

NEXO

User Guide

Basic device settings

AP mode

Hold your finger on the right bridge for 3 seconds
The switch enters the modem mode then you can start from Do it through the application.

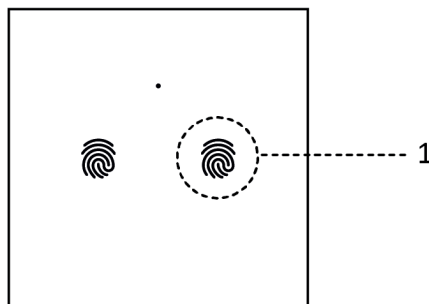

Reset Device

Hold your finger on the right bridge for 7 seconds
The switch will restart automatically.

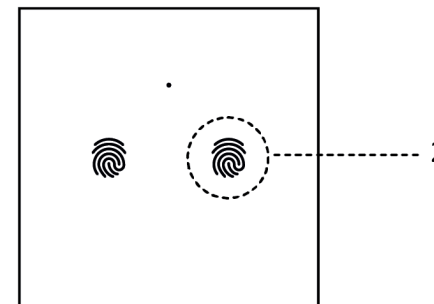

WiFi Light

- Slow flashing mode means the device is running
Trying to connect to the modem
- Fast flashing mode means AP mode
- When the Wi-Fi light is off, it means that The switch is malfunctioning.

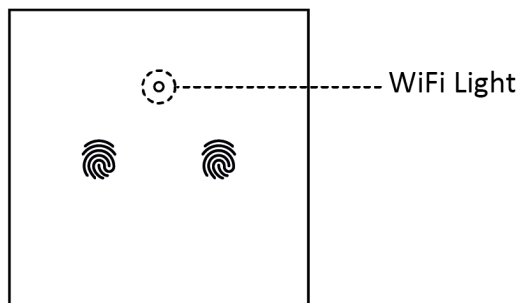

Safety Tips

- Before installing, be sure to disconnect the main power fuse.
- Use a phase meter or insulating screwdrivers and safety gloves to connect the switch.
- If necessary, be sure to get help from the installer to install the switch.
- Do not install the switch on worn and inefficient wiring.
- Prior to installation, make sure that the installation site is clean and not damp come

Warning!!

- Avoid connecting the switch to high power appliances
- Do not install the device in humid environments separately
- Avoid connecting the device to shared or anonymous modems
- Do not install the switch in spaces with a temperature of more than 45 degrees
- Change the device password at regular intervals for device security
- Do not share your username and password with unknown individuals

Connect switch to the application

- Download NEXO applications from reputable markets or company site.
- Install on your smartphone.
- Run the program and log in with the username and password received from the company.
- Touch the icon **+** from the left side of the app screen.

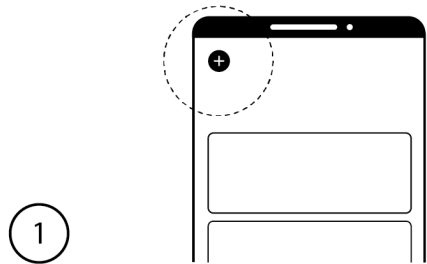

- Touch the scan QR button.
- Barcode scanning printed on smart switch.
- Receive and display device information.
- Touch the next button.

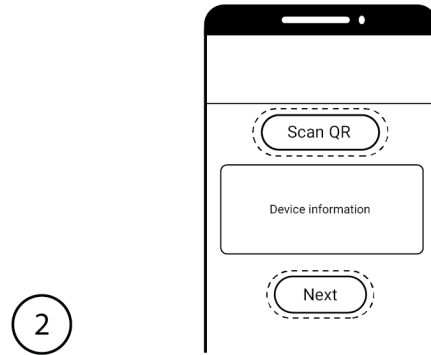

- Enter the following information as:
SSID ----- Modem name connected to your smartphone
Password ----- Modem connection password
- Touch the next button.

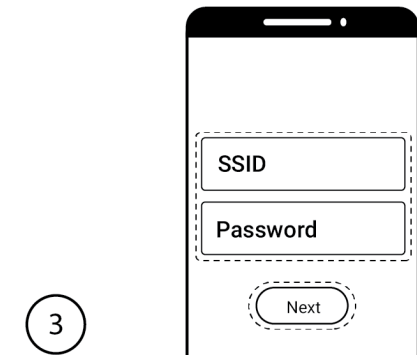

- Select the desired room of the switch

Select one of the default rooms after completing the device setup
Rooms are the editable location of choice.

- Touch the next button.

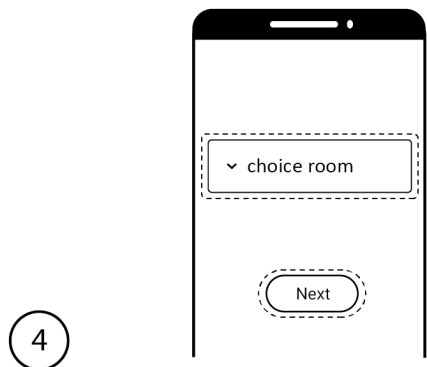

- Test the correct operation of the device by turning it on and off.
- Touch the next button.

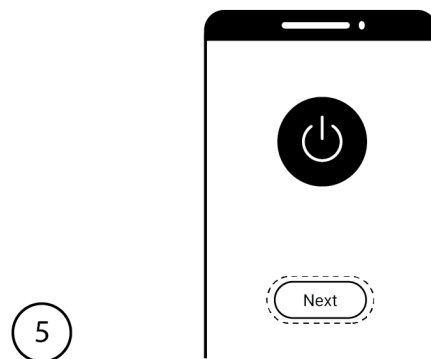

- The device has been successfully launched by displaying the tick icon.
- Touch the Finish button and enjoy working with the switch.

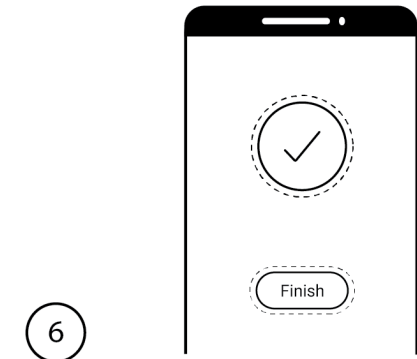

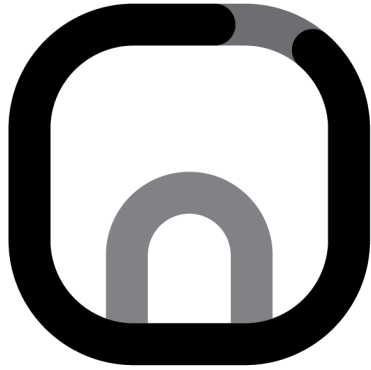

NEXO

Installation Help

Install the switch on the wall

- First, remove the front panel of the switch from the body with a tool.
- Slowly separate the tabs from the panel as shown.

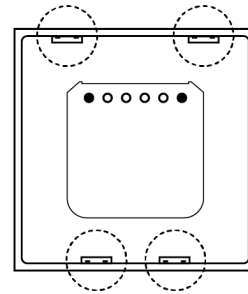

Connect the switch to the power supply

- Before installing, be sure to disconnect the main power fuse.
- Connect the wires as shown below.

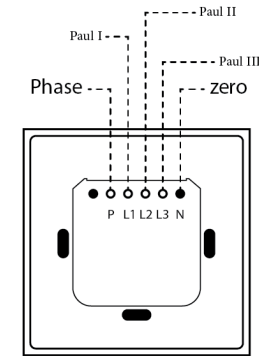

Final level

- You can install the switch from the holes marked in the picture with the screws inside the box.
- Finally, put the front panel on the switch and put the tabs in place and use.

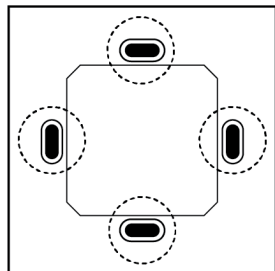

Install smart switch

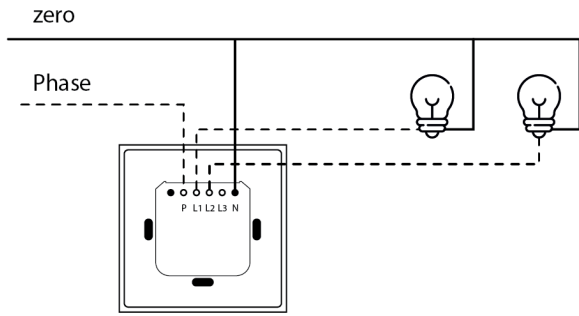

Install smart conversion switch

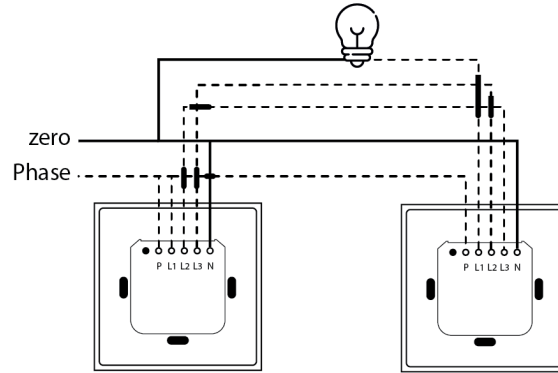

Install conversion old switch

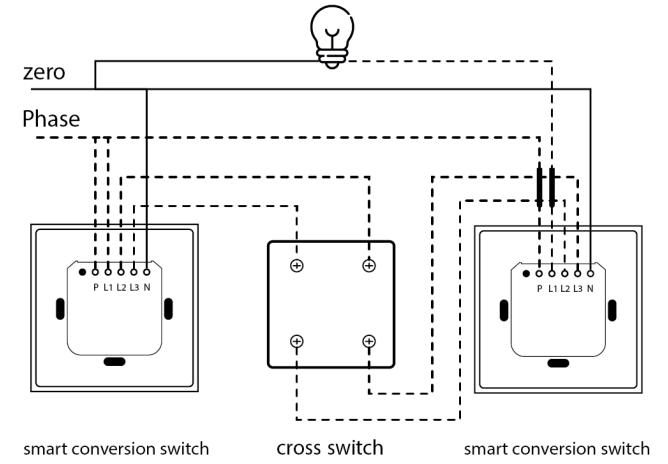

Install old switch

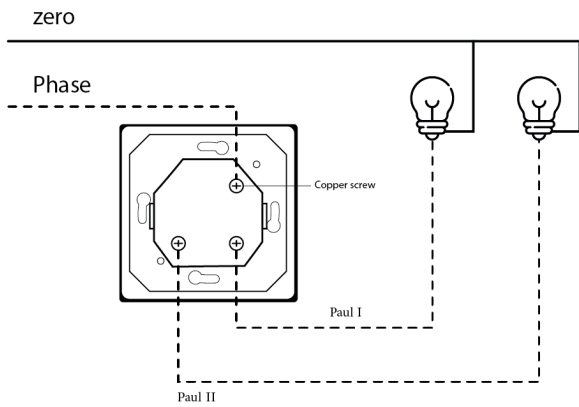

Install conversion old switch

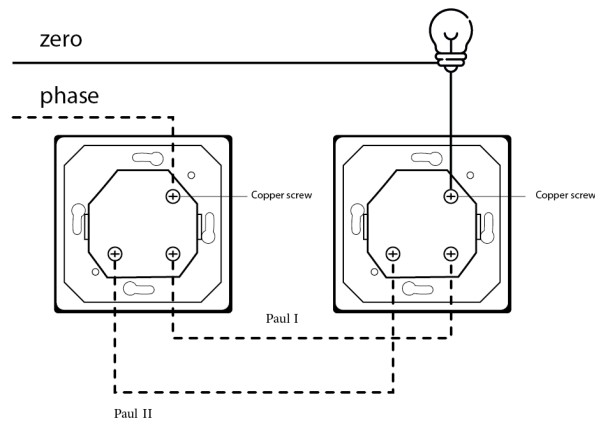

Install smart cross switch

