

# NEXO

User Guide

## Install Bus 8 channel

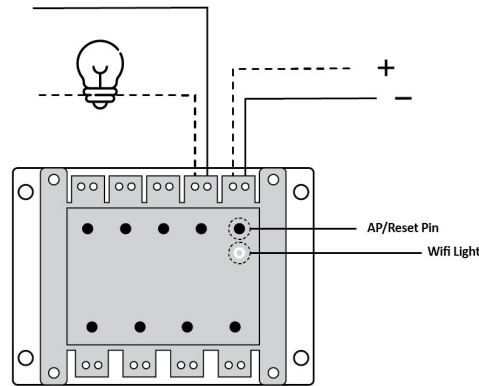

## Basic device settings

### AP mode

Hold your finger on AP Pin for 3 seconds the Bus enters the AP mode then you can start from Do it through the application.

### Reset Device

Hold your finger on the Reset Pin for 7 seconds the Bus will restart automatically.

## WiFi Light

- Slow flashing mode means the device is running trying to connect to the modem
- Fast flashing mode means AP mode
- When the Wi-Fi light is off, it means that the Bus is malfunctioning.

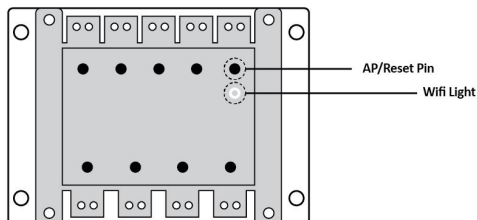

## Safety Tips

- Before installing, be sure to disconnect the main power fuse.
- Use a phase meter or insulating screwdrivers and safety gloves to connect the Bus.
- If necessary, be sure to get help from the installer to install the Bus.
- Do not install the Bus on worn and inefficient wiring.
- Prior to installation, make sure that the installation site is clean and not damp come

## Warning!!

- Avoid connecting the Bus to high power appliances
- Do not install the device in humid environments separately
- Avoid connecting the device to shared or anonymous modems
- Do not install the switch in spaces with a temperature of more than 45 degrees
- Change the device password at regular intervals for device security
- Do not share your username and password with unknown individuals

## Connect switch to the application

- Download NEXO application from reputable markets or company site.
- Install on your smartphone.
- Run the application and log in with the username and password received from the company.
- Touch the icon **+** from the left side of the app screen.

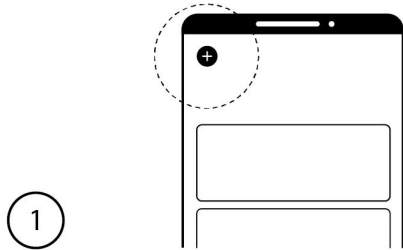

- Touch the scan QR button.
- Barcode scanning printed on Bus device.
- Receive and display device information.
- Touch the next button.

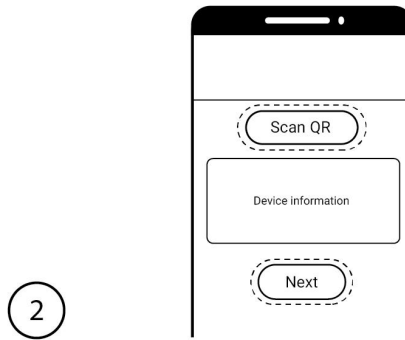

- Enter the following information as:  
SSID ----- Modem name connected to your smartphone  
Password ----- Modem connection password
- Touch the next button.

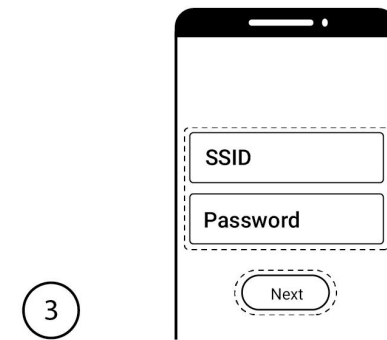

- Select the desired room of the Bus

Select one of the default rooms after completing the device setup  
rooms are the editable location of choice.

- Touch the next button.

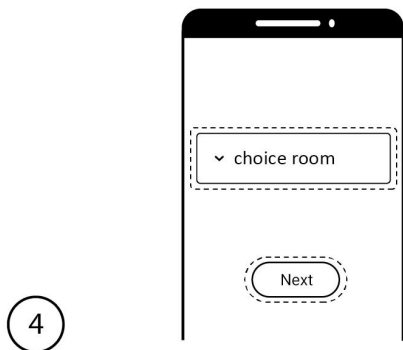

- Test the correct operation of the device by turning it on and off.
- Touch the next button.

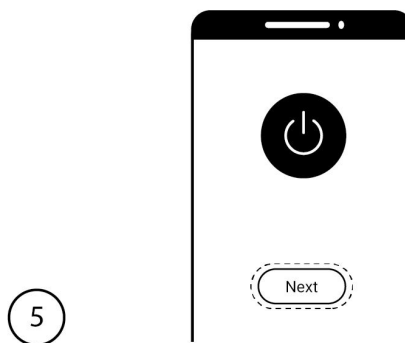

- The device has been successfully launched by displaying the tick icon.
- Touch the Finish button and enjoy working with the Bus.

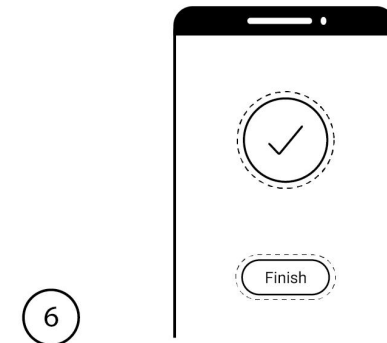

Uses of the Bus

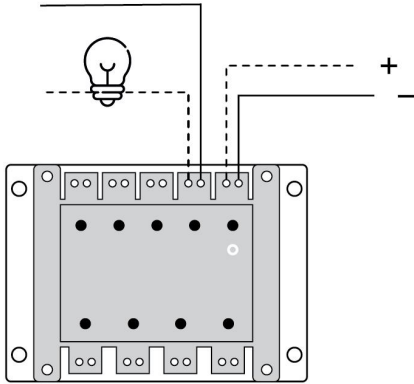

Uses of the Bus

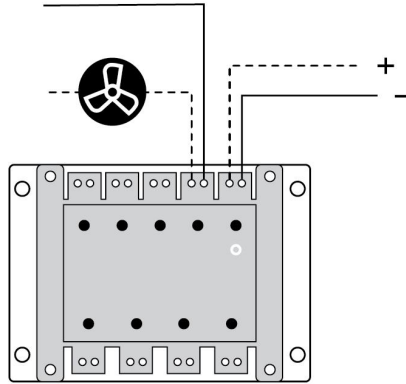

Uses of the Bus

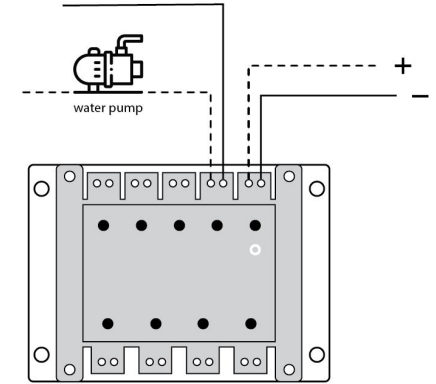

Uses of the Bus

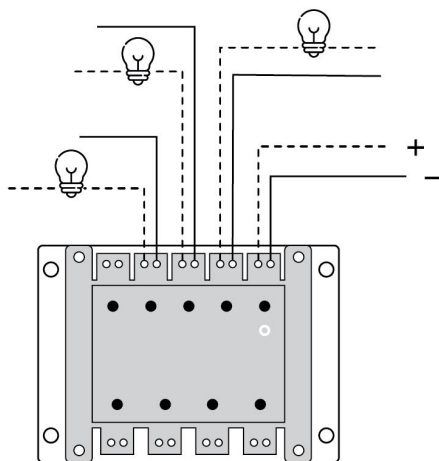

Uses of the Bus

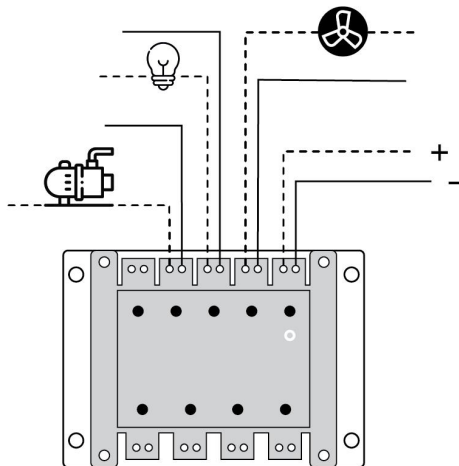

Uses of the Bus

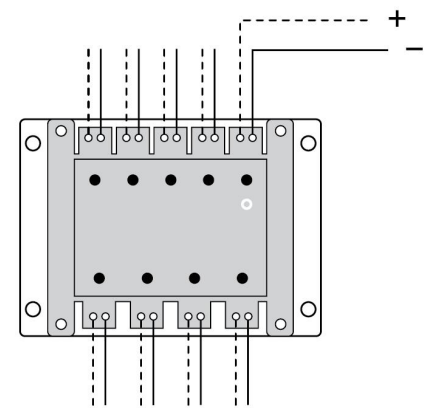

You can use all 8 sockets for different devices